

# MA20C

## Digital controller

### Instruction manual

Thank you for purchasing SHIMAX products. Please check that the delivered Product is the item you ordered. Please do not begin operating this product until You have read this instruction manual thoroughly and understand its contents.

#### 「Notice」

Please ensure that this manual is given to the final user of the instrument.

#### Preface

This instruction manual is meant for those who will be involved in wiring, installation, operation and routine maintenance of the MA20C.

This manual describes the care, installation, wiring, function, and proper procedures regarding the operation of MA20C. Keep this manual on hand while using this device.

Follow the guidance provided herein.

#### 1 . Matters regarding safety

For matters regarding safety, potential damage to equipment and/or facilities and additional instructions are indicated as follows.

This heading indicates hazardous conditions that could cause injury or death of personnel. Exercise extreme caution as indicated.

#### 「⚠ WARNING」

This heading indicates hazardous conditions that could cause damage to equipment and/or facilities. Exercise extreme caution as indicated.

#### 「⚠ CAUTION」

This heading indicates additional instructions and/or notes

#### 「NOTE」

#### 「⚠ WARNING」

MA20C is designed for controlling temperature, humidity, and other physical subjects. It must not be used in any way that may adversely affect safety, or working conditions.

#### 「⚠ CAUTION」

To avoid damage to the connected equipment, facilities or the product itself due to a fault of the product, safety countermeasures must be taken before usage, such as proper installation of the fuse and the overheating protection device. No warranty, expressed or implied, is valid in the case of usage without having implemented proper safety counter measures.

#### 「⚠ CAUTION」

The ⚠ mark on the plate affixed to the instrument:

On the terminal nameplate affixed to the case of your instrument, the ⚠ mark is printed. This is to warn you of the risk of electrical shock which may result if the charger is touched while it is energized. The external power circuit connected to the power terminal of this instrument must have a means of turning off the power, such as a switch or breaker.

Install the switch or breaker adjacent to the instrument in a position which allows it to be operated with ease, and with an indication that it is a means of turning off the power.

Fuse:

Since the instrument does not have a built-in fuse, do not forget to install a fuse in the power circuit to be connected to the power terminal. The fuse should be positioned between the switch or breaker and the instrument and should be attached to the L side of the power terminal.

Fuse Rating: 250V AC 0.5A/medium lagged or lagged type.

Use a fuse, which meets the requirements of IEC127.

Load voltage/current to be connected to the output terminal and the alarm terminal should be within the rated range. Otherwise, the temperature will rise and reduce the life of the product and/or result in problems with the product.

Voltage different from that of the input specification should not be connected to the input terminal.

It may reduce the life of the product and/or result in problems with the product.

Input, voltage pulse output, and current output are not isolated electrically from inside circuits.

When ground thermocouples are used, the control output terminal should not be connected to earth.

(If connected, wraparound causes errors.)

#### 「⚠ CAUTION」

This instrument has basic insulation between the power supply and the input-output. When enforced insulation is needed, the input/output terminals should be connected A: to a device with no exposed chargers, or B: to a device with basic insulation suitable for the highest voltage of power supply and input/output section.

This instrument is provided with a vent for heat discharge. Take care to prevent metal or other foreign matter from obstructing the vent. Failure to do so may result in problems with the product and may even result in fire.

Do not block the vent or allow dust to accumulate. The rise in temperature or insulation failure caused by blocking the vent may result in reducing the life of the product and/or problems with the product. Repeated tolerance tests against voltage, noise, surge, etc. may lead to deterioration of the instrument. No modification or irregular usage is allowed.

#### 2 . Introduction

##### 2 - 1 . Check before use

Before using this product, you are required to check the model code, the external view of the product and the accessories to make sure that there is no error, damage, or shortage of delivered items.

Confirmation of model code: Check the model codes on the case of the product to ascertain that the delivered item is what you ordered by referring to the following code table.

Example of model code

<b>MA20</b>	<b>C</b>	<b>-</b>	<b>M</b>	<b>C</b>	<b>F</b>	<b>-</b>	<b>2N</b>	<b>-</b>	<b>0</b>
1	2		3	4	5		6		7

Item

- |                   |   |                   |              |          |                                |
|-------------------|---|-------------------|--------------|----------|--------------------------------|
| 1. Series         | MA20  | 2. Classification | C-controller | 3. Input | M: multi V: voltage I: current |
| 4. Control output | C: contact S: voltage pulse I: current (4~20mA)   |                   |              |          |                                |
| 5. Power Supply   | F-: 90-264V AC L-: 21.6-26.4V DC/AC   |                   |              |          |                                |
| 6. Option         | 0N-: without 1N-: alarm output 1 point 2N-: alarm output 2 points<br>0D-: external control input (DI) 2 points<br>1D-: alarm output 1 point + external control input (DI) 2 points<br>0T-: analog output (4~20mA) 1T-: alarm output 1 point + analog output<br>0R-: communication of RS-485<br>1R-: alarm output 1 point + communication of RS-485<br>1B-: alarm output 1 point with buzzer 2B-: alarm output 2 point with buzzer |                   |              |          |                                |
| 7. Remarks        | 0: without 9: with  |                   |              |          |                                |

Check of accessories

Instruction manual: 1 set

「NOTE」: Contact our representative or our local office concerning any problems with the product and accessories, or for any inquiry.

##### 2 - 2 . Caution for use

- (1) Avoid operating the front panel keys with hard or sharp objects.  
Touch the keys lightly with fingertips.
- (2) To clean, wipe gently with a dry cloth. Avoid using solvents such as thinner.

#### 3 . Installation and wiring

##### 3 - 1 . Installation site (environmental conditions)

#### 「⚠ CAUTION」

Do not use this instrument under the following conditions. Otherwise, the likelihood of fire and/or other dangerous situations are considerable.

- (1) Where flammable gas, corrosive gas, oil mist or dust that can deteriorate electrical insulation is generated or is abundant.
- (2) Where the temperature is below 0 or above 50
- (3) Where the humidity is over 90%RH or where condensation occurs.
- (4) Where highly intense vibration or impact is generated or can affect the operation of the product.
- (5) Near high voltage power lines or where inductive interference can affect the operation of the product.
- (6) Where there are dewdrops or direct sun light.
- (7) Where the altitude is above 2,000m.

「NOTE」: The environmental conditions here comply with the installation category and the pollution degree 2 set by IEC664.

##### 3-2. Mounting.

- (1) Machine the mounting hole by referring to the panel-cut illustration in Section 3-3.
- (2) Applicable thickness of the mounting panel is 1.2~3.2mm. (With metal fittings, it can be 1.0~4.0mm.)
- (3) As this product provides mounting fixture, insert the product into the panel.

「NOTE」: MA20C is a panel set-up type. Please use the product after setting up to the panel.

3 - 3 . External dimension and panel cutout  
MA20C external dimensions (unit: mm)

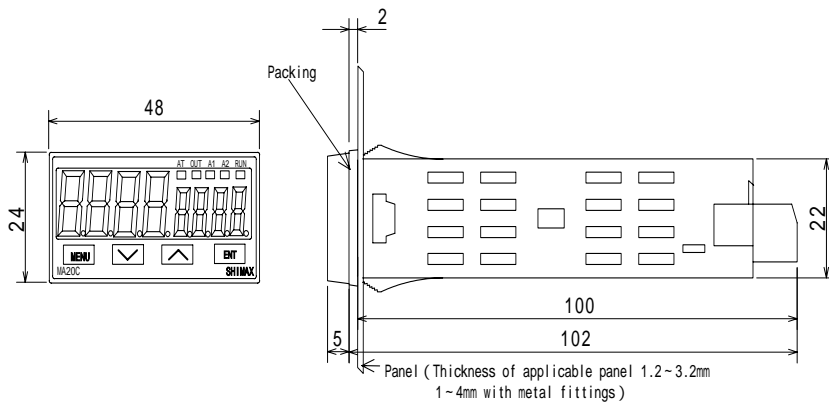

MA20C panel cutout (unit : mm)

Individual Installation for one unit and more than one unit closely mounted each in one hole

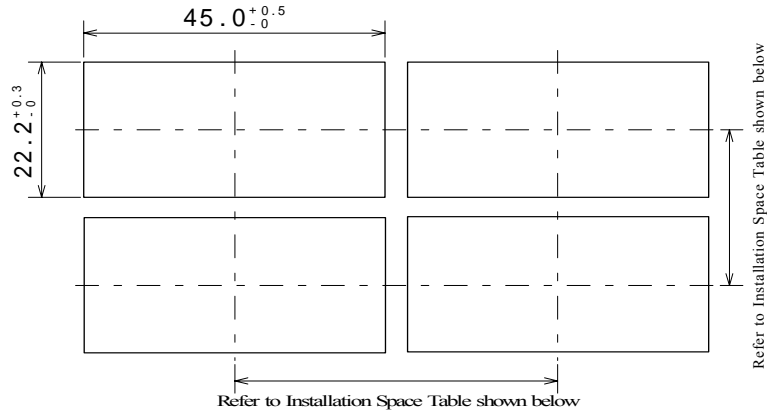

Min. Installation Space According to Thickness of the Panel

Thickness of Panel	Installation Space (Vertical)	Thickness of Panel	Installation Space (Vertical)	Installation Space (Horizontal)
1.0	25.0	2.3	24.0	More than 48.0 as for horizontal direction
1.2	25.0	2.8	24.0	
1.6	24.4	3.2	24.0	More than 66.0 with metal fittings
2.0	24.0			

Horizontally Consecutive Installation in One Hole (Max. 6 units) Non-application of IP66

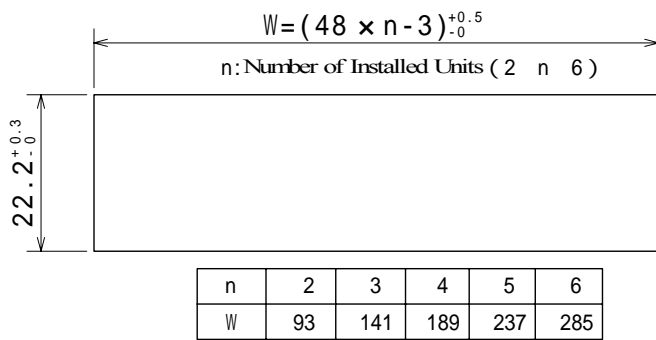

Vertically Consecutive Installation in One Hole (Max. 6 units) Non-application of IP66

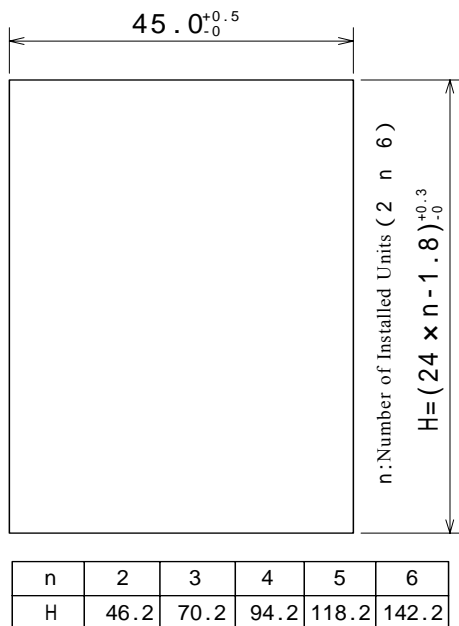

「NOTE」 : Metal fittings are needed for each unit in case of vertically consecutive installation in one hole.

External View of Installation with Metal fittings

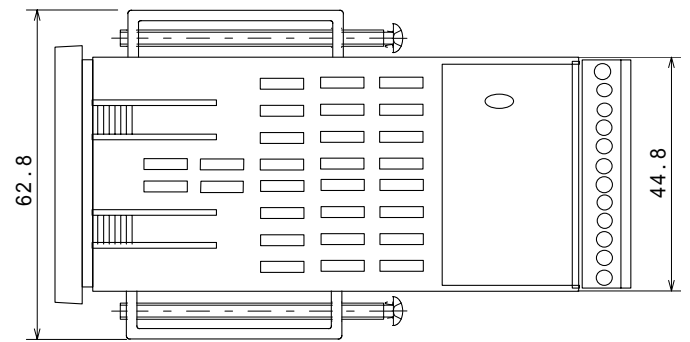

3 - 4 . Wiring

「WARNING」

- ◎To prevent electrical shock, turn off electricity during wiring operation.
- ◎Avoid touching the wired terminals and chargers while supplying power.

- (1) Wiring operation should be done according to the instruction of the terminal arrangement plan in section 3-5
- (2) In case of thermocouple input, choose the compensation wire suitable to the thermocouple type.
- (3) In case of R.T.D. input, leads should be less than 5 Ω in resistance and three leads should have the same resistance.
- (4) Input signal line should not be laid in the same wire or duct as that of the high voltage line.
- (5) Shield wiring (single point grounding) is effective for static induction noise.
- (6) Short interval twisted pair wire for input signal is effective for electromagnetic induction noise.
- (7) When wiring, the connector terminal can be removable if it is pulled right and left one after the other as shown in the drawing below.

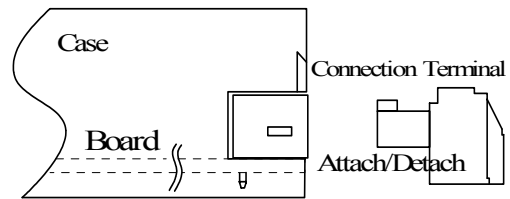

- (8) To avoid wiring slip and short circuit, use the suitable cable, insert it thoroughly, and fasten the connection screws tightly with a minus driver.

Tightening torque: 0.2 ~ 0.25N•m (recommended performance)  
0.3 N•m (guaranteed performance)

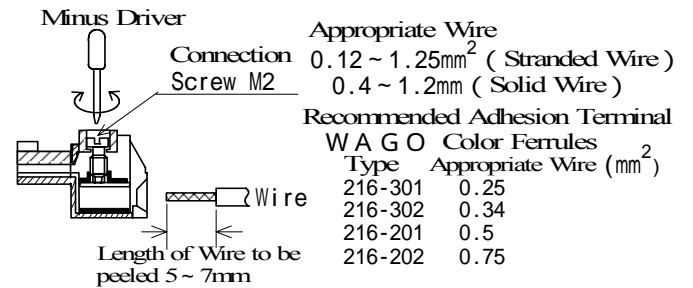

3-5. Terminal arrangement plan

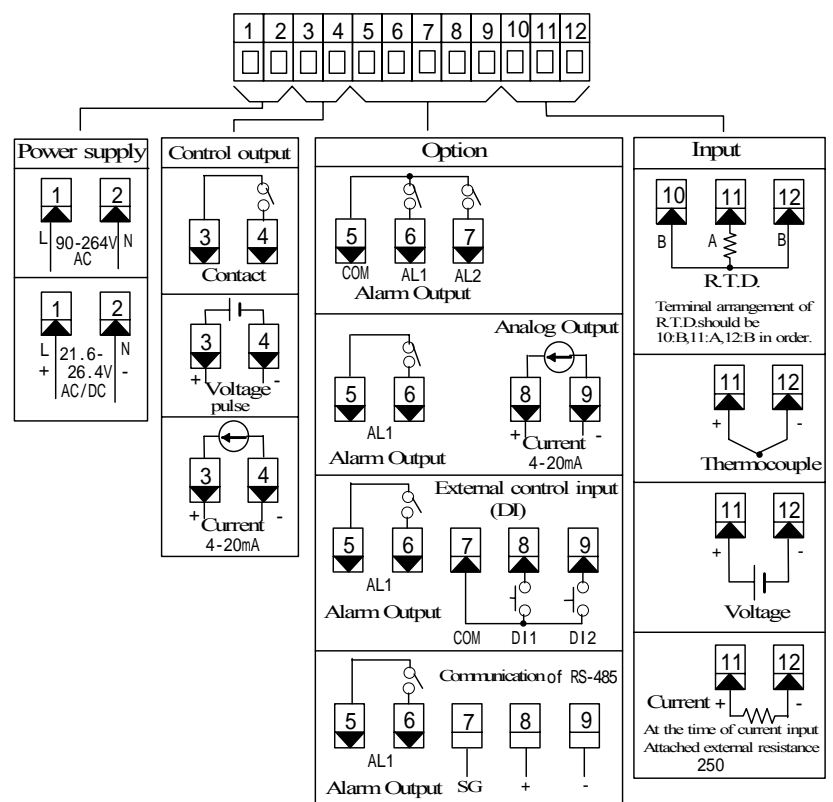

「NOTE」 : When input type is thermocouple or voltage a short circuit between 10 and 12 terminals cause measurement errors.

4 . Description of front panel

4 - 1 . Drawing and the name of parts.

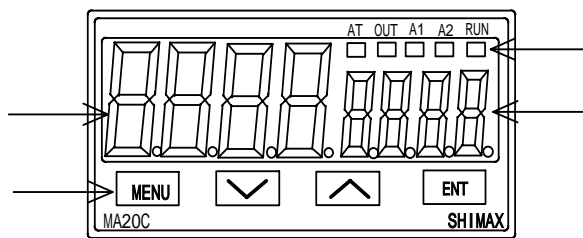

4 - 2 . Description of parts on the front panel

: Display section of measured value (PV) (red)  
Measured value (PV) and type of setting on each setting screen are displayed.

: Display section of target value (SV) (yellow)  
Target value (SV) and set value on each setting screen are displayed.

: Monitor LED section

- (1) Control output monitor LED OUT (yellow)  
At the time of contact or voltage pulse output, LED lights up with output ON, and turns off with output OFF. At the time of current output, LED turns off with 0% output, lights up with 100% output, and blinks between 0% and 100% according to ratio.
- (2) Alarm output monitor LED A1, A2 (red)  
LED lights up when assigned alarm output turns ON.

(3) Auto tuning action monitor LED AT (yellow)  
When ON is chosen on AT screen, or when AT is chosen in the external control input (DI), AT starts operating and LED blinks, and turns off when AT is cancelled or automatically completed.

(4) RUN monitor LED RUN (yellow)  
When RUN is chosen on action mode screen or in the external control input (DI), LED lights up and turns off with Stby. When Manual output is chosen on output monitor screen or in the external control input (DI), LED blinks.

: Key-switch section

- (1) **MENU** (MENU) key  
Press **MENU** key to move on to the next screen in each screen.  
Press **MENU** key for three seconds on the basic screen and the screen jumps to the lead screen of Mode 1. Press **MENU** key for three seconds on the lead screen of each of Mode screens and the screen jumps to the basic screen
- (2) **▼** (DOWN) key  
One press of **▼** key decreases the set value by one. By pressing the key, the value continues decreasing.  
During setting, a dot beside the least decimal place is blinking.
- (3) **▲** (UP) key  
One press of **▲** key increases the set value by one. By pressing the key, the value continues increasing. During setting, a dot beside the least decimal place is blinking.
- (4) **ENT** (ENTRY) key  
Press **ENT** key to register the setting changed by **▲** or **▼** key. (A dot beside the least decimal place stops blinking.)  
Press **ENT** key on the control output screen for three seconds to choose between automatic output and manual output.  
Press **ENT** key on the lead screen of each of Mode screens and the screen moves to a setting screen.

5 . Description of screens

5 - 1 . How to move to another screen

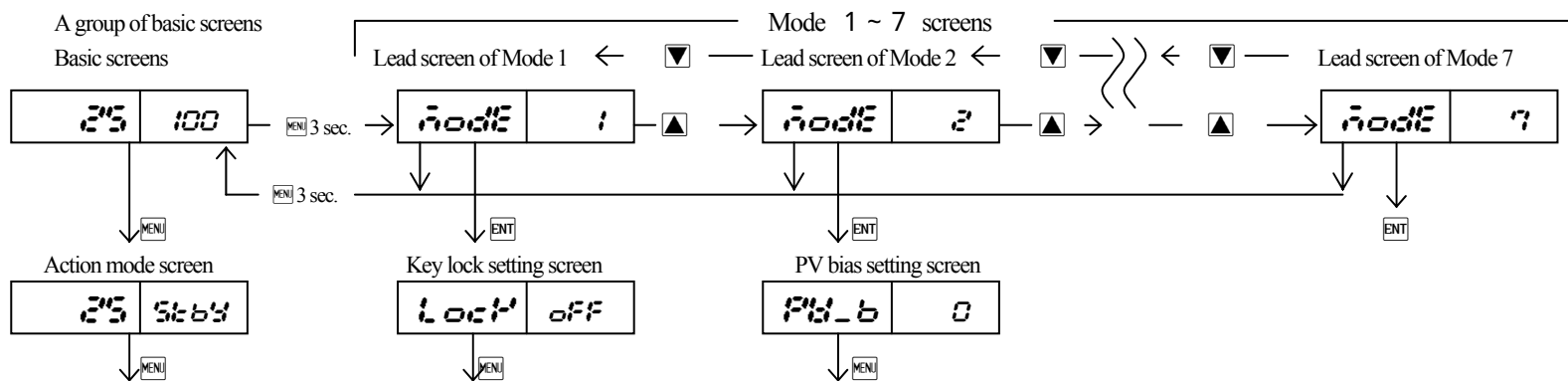

- Press **MENU** key on the basic screen to move to another basic screen.
- Press **MENU** key on the basic screen for three seconds to jump to the lead screen of Mode 1.
- Press **▲** key on the lead screen of Mode 1 to move to the lead screen of Mode 2, Mode 3 in order. (When there is no option assigned to Mode 4 ~ Mode 7, it skips)
- Press **▼** key on the lead screen of Mode 1 to move to the lead screen of Mode 7, Mode 6 in order. (When there is no option assigned to Mode 4 ~ Mode 7, it skips)
- Press **ENT** key on the lead screen of Mode 1 ~ 7 to move to the first setting screen of each Mode.
- Press **MENU** key on the first setting screen of each Mode to move to the next setting screen.

5 - 2 . How to set

To change settings, display an appropriate screen and change the setting (value or function) by pressing **▲** or **▼** key. Then press **ENT** key to register the setting. On the output monitor screen of a group of basic screens, the type of control output can be chosen from "automatic" or "manual". Display the output monitor screen and press **ENT** key for three seconds to transfer from automatic to manual. Then by pressing **▲** or **▼** key, settings can be changed. In this case, **ENT** key doesn't have to be pressed to register the settings. To shift back from manual to automatic, press **ENT** key for three seconds as well. (Note: Switchover between automatic output and manual output cannot be done unless Key Lock is OFF or when STBY and AT are active.)

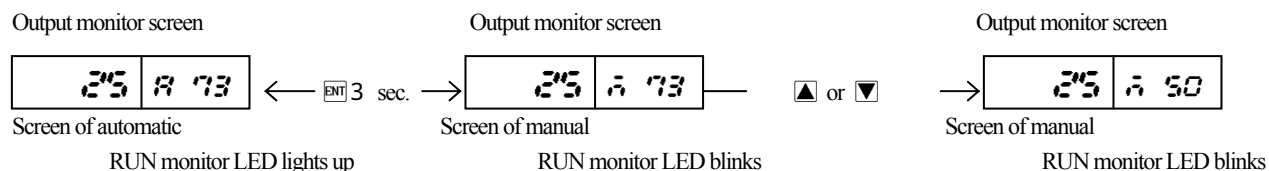

5 - 3 . Power-on and initial screen display

At power-on, the display section shows initial screens successively for one second each, then moves on to the basic screen.

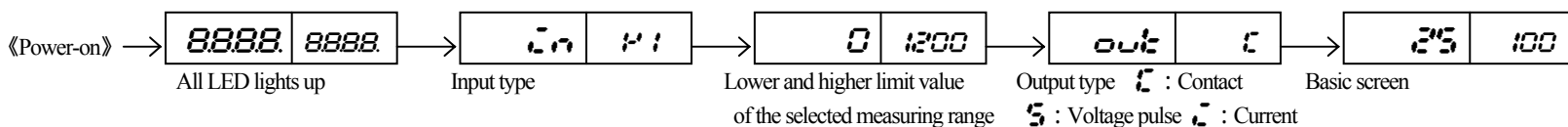

( 1 ) A group of basic screens

Basic screen

Executed SV initial value: Sensor input 0

Linear input Lower limit of scaling range

Setting range: Sensor input Within measuring range

Linear input Within scaling range

Both of them should be within SV limit range

On the basic screen, the 4-digit-number section on the left displays measuring value (PV) and the 4-digit-number section on the right displays target value (SV).  
(Note: Measuring value is shown as PV and target value as SV.)

Action mode screen

Initial value: **Stby** (Stand-by)

Setting range: **Stby** Out of operation {Output OFF (0%)} action

**run** Automatic or manual control output action

Choose "run" with **▲** key and register it with **ENT** key. LED of RUN on the monitor lights up while automatic control is active, and blinks while manual control is active.

Choose "Stby" with **▼** key and register it with **ENT** key. LED of RUN on the monitor turns off and the control stops ({Output OFF (0%)}).

If RUN is assigned to external control input DI (1 or 2), DI takes precedence. Unless the assignment is cancelled, no key operation is possible.

When measuring range, unit, scaling or output specifications are changed, the setting is initialized and goes back to "Stby".

Output monitor screen

Manual output setting range: 0 ~ 100% (within output limit)

When automatic output is chosen, just the monitor is displayed.

When "automatic output" is chosen, the fourth place of the 4-digit number displays **R**. When "manual output" is chosen, the fourth place of the 4-digit number displays **r**.

Refer to Section 5-2 as for switchover between automatic and manual and setting in manual operation.

When action mode is "**Stby**", manual output is cancelled.

When the power is cut and then turns on again, the output setting goes back to the output action just before the power is cut.

When **run** is assigned to DI (1 or 2), DI takes precedence. The switchover between automatic and manual cannot be done by key operation. Only output value at the time of manual operation can be changed.

AT (Auto Tuning) screen

Initial value: **off**

Setting range: **off, on**

When ON is chosen, AT is executed. When OFF is chosen, AT is cancelled.

When "stby", "manual output", or "P=OFF" is chosen, there is no display.

When key lock is not OFF or at the time of scale-over, AT cannot be executed.

During AT operation, no key operation can be done except cancellation of AT and setting of "stby and "key lock".

Except normal completion of AT operation, time-over (200 minutes), scale-over, choice of "stby", or cancellation of AT forces AT operation to stop.

Note: Even if output limit is set at any value other than 0 ~ 100%, AT ignores the setting and is executed either at 0% or 100%.

First SV setting screen

Initial value: Sensor input 0

Linear input lower limit of scaling range

Setting range: Sensor input within measuring range

Linear input within scaling range

Both of them should be within SV limit range

When First SV is the executed one, the value is displayed on the basic screen.

When measuring range, unit, or scaling range is changed the setting is initialized.

Second SV setting screen

Initial value: the same as those of First SV

Setting range: the same as those of First SV

When Second SV is the executed one, the value is displayed on the basic screen.

When measuring range, unit, or scaling range is changed the setting is initialized.

This screen is displayed when the second SV is assigned to DI (1 or 2). When the terminal of the assigned DI is shorted, the setting becomes executed SV.

Third SV setting screen

Initial value: the same as those of First SV

Setting range: the same as those of First SV

When Third SV is the executed one, the value is displayed on the basic screen.

When measuring range, unit, or scaling range is changed the setting is initialized.

This screen is displayed when the third SV is assigned to DI (1 or 2). When the terminal of the assigned DI is shorted, the setting becomes executed SV.

Alarm 1 operating point setting screen

Initial value: higher limit absolute value within measuring range

higher limit of scaling range

Lower limit absolute value within measuring range

Higher limit deviation 2000

Lower limit deviation -9999

Within deviation 0

Beyond deviation 2000

Control loop/disconnection 9999

Setting value: Higher limit absolute value within measuring range within scaling range

Lower limit absolute value within measuring range within scaling range

Higher limit deviation **-1999 ~ 2000** unit

Lower limit deviation **-1999 ~ 2000** unit

Within higher and lower deviation **0 ~ 2000** unit

Beyond higher and lower deviation **0 ~ 2000** unit

Control loop/disconnection **1 ~ 9999** seconds

Operating point of the alarm type assigned to Alarm 1 can be set.

When there is no alarm option, or when "AL1 non" is chosen, there is no display.

Each deviation alarm and control loop/disconnection alarm take effect when action mode is "run" and when "automatic output" is chosen.

Each deviation alarm is PV deviation to the executed SV

Control/disconnection alarm watches time when PV is out of proportional band.

At the time of ON-OFF operation, it watches time when PV is out of differential gap

Alarm 2 operating point setting screen

Initial value, setting range, and other conditions are the same as those of Alarm 1.

Latching cancellation screen

Initial value: **rSt 1**

Setting range: **rSt 1** cancellation of alarm 1

**rSt 2** cancellation of alarm 2

**ALL** simultaneous cancellation of all the alarm

When **on** is chosen on latching setting screen of each alarm mode, **rSt** number and **ALL** are displayed. When latching is "on", once alarm turns on, the alarm output condition continues even if alarm is OFF.

On this screen, on-going alarm output can be cancelled.

When alarm is in latching condition, a dot beside the least decimal place blinks. The blinking indicates that it is possible to cancel the alarm setting.

When **ENT** key is pressed, the alarm is cancelled and the dot stops blinking.

However, the condition is within alarm output region, cancellation is impossible.

Back to the basic screen

( 2 ) A group of Mode 1 screens

Lead screen of Mode 1

This screen is displayed when **ENT** key is pressed for 3 seconds on the basic screen.

There is no setting on this screen. Press **ENT** key and the screen will shift to the first setting screen, Key lock setting screen.

Key lock setting screen

Initial value: **off**

Setting range: **off, 1, 2, 3**

**1** Only the executed SV (on the basic screen) and "key lock" can be changed.

**2** Only "key lock" can be changed.

**3** Only "key lock" can be changed, and there is no display of SV on the basic screen.

Note: Even if "key lock" is set as 1 or 2, manual output value can be changed.

SV limit lower value setting screen

Initial value: lower limit of measuring range

Setting range: lower limit of measuring range ~ higher limit of measuring range - 1

Lower limit of target value can be set.

Lower value of SV limit takes precedence over higher value. If higher value is set lower than the lower value, higher value is automatically set at 1 higher than the lower value.

SV limit higher value setting screen

Initial value: higher limit of measuring range

Setting range: SV limit lower value + 1 ~ higher limit of measuring range

Higher limit of target value can be set.

Back to the lead screen of Mode 1

( 3 ) A group of Mode 2 screens

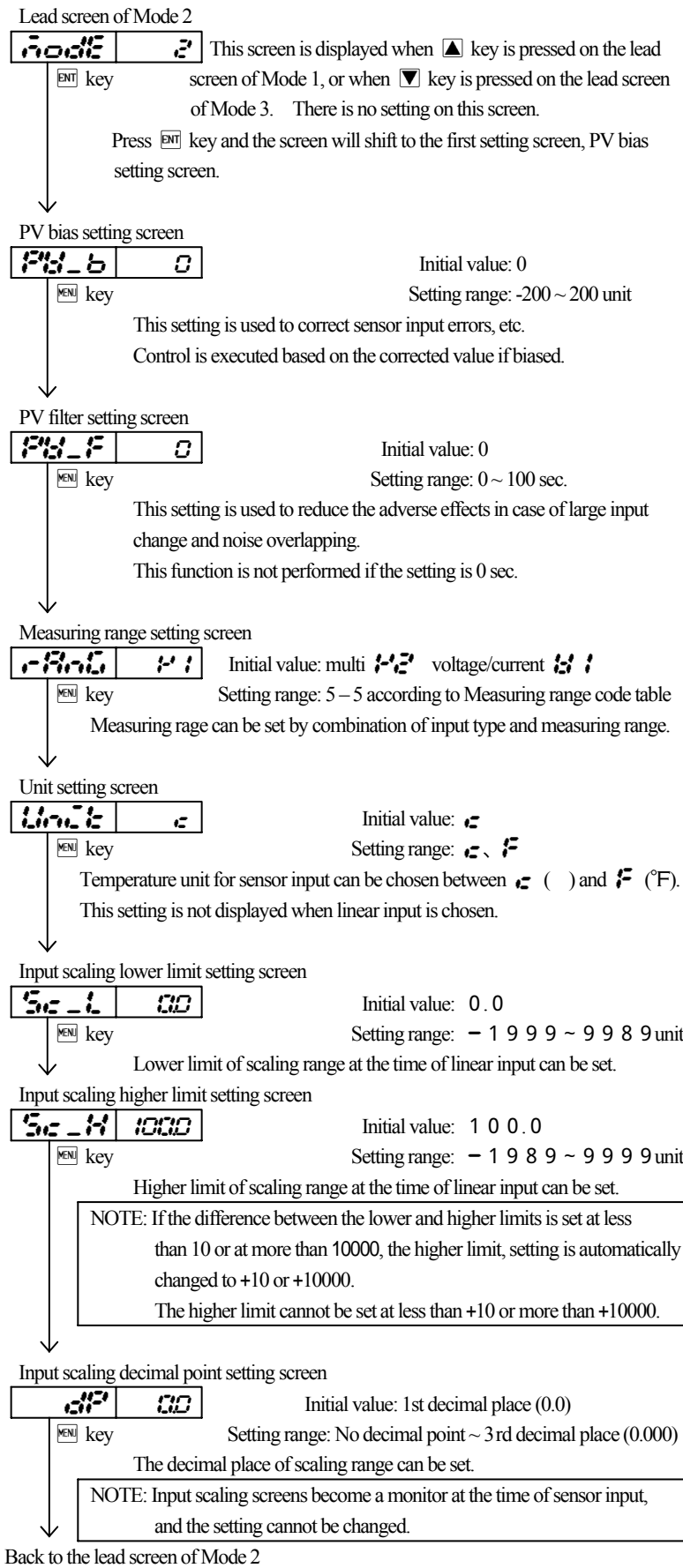

Back to the lead screen of Mode 2

( 4 ) A group of Mode 3 screens

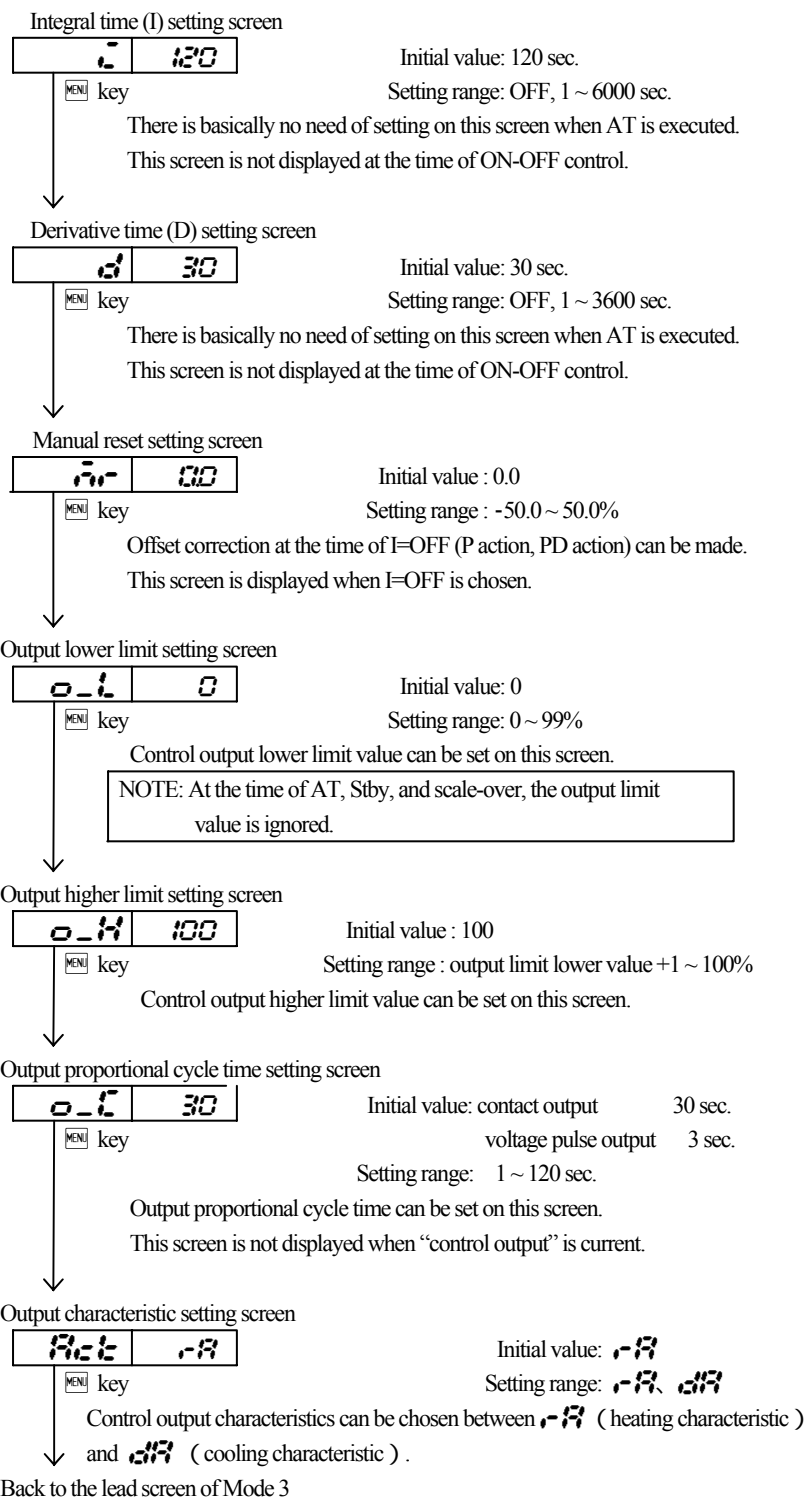
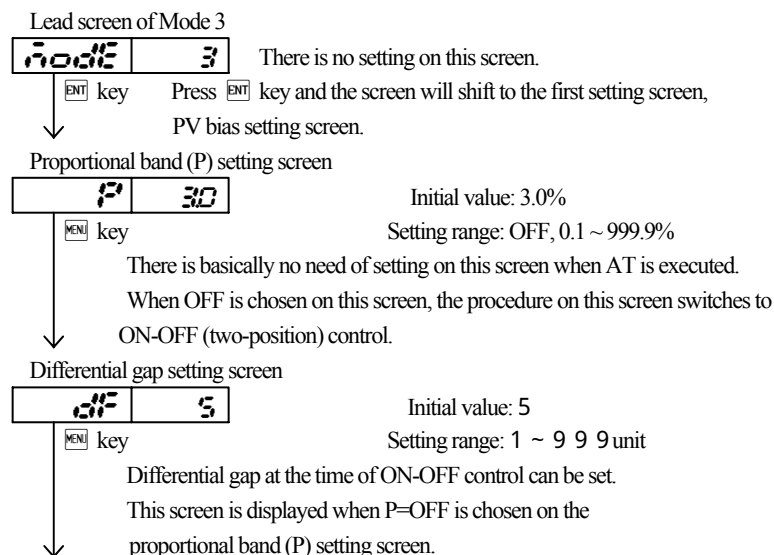

( 5 ) A group of Mode 4 screens

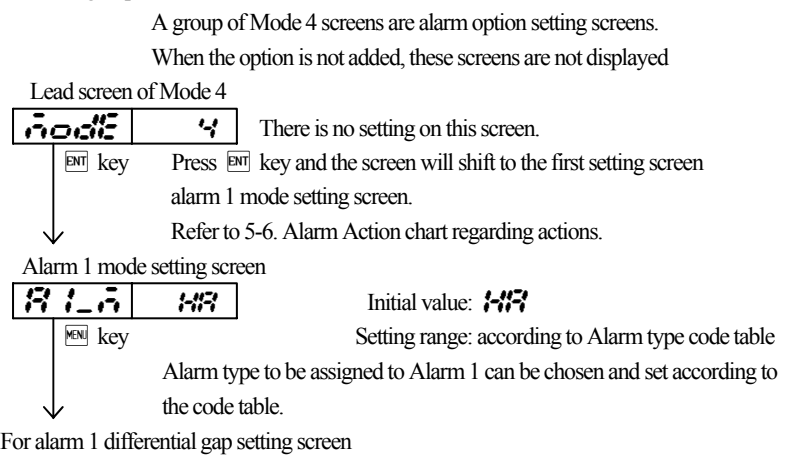

Alarm type code table

Alarm code	Alarm type	Alarm code	Alarm type
<b>non</b>	Not assigned	<b>Ld</b>	Lower limit deviation
<b>HR</b>	Higher limit absolute value	<b>cd</b>	Within deviation
<b>LR</b>	Lower limit absolute value	<b>od</b>	Beyond deviation
<b>So</b>	Over scale	<b>Lb</b>	Control loop/disconnection
<b>Hd</b>	Higher limit deviation		

When measuring range, unit, or scaling range is changed the setting is initialized.

Alarm 1 differential gap setting screen

**R1\_d** 5

Initial value: 5 unit  
Setting range: 1 ~ 9 9 9 unit

MENU key

ON-OFF differential gap of Alarm 1 can be set on this screen.  
This screen is not displayed when Alarm 1 mode is *non*, *So*, and *L\_d*.  
When measuring range, unit, scaling range or Alarm 1 mode is changed, the setting is initialized.

Alarm 1 stand-by action setting screen

**R1\_S** OFF

Initial value: OFF  
Setting range: OFF, 1, 2

MENU key

OFF : no stand-by action  
1 : stand-by action only at the time of power-on  
2 : stand-by action at the time of change of each alarm operating point and change of the executed SV by deviation alarm warning when the power is on.  
This screen is not displayed when Alarm 1 mode is *non*, and *So*.  
When measuring range, unit, scaling range or Alarm 1 mode is changed, the setting is initialized.

Alarm 1 latching setting screen

**R1\_L** OFF

Initial value: OFF  
Setting range: OFF, ON

MENU key

When latching is set as *on*, once alarm output turns on, the alarm output condition continues even if alarm turns OFF.  
This screen is not displayed when Alarm 1 mode is *non*.  
When measuring range, unit, scaling range or Alarm 1 mode is changed, the setting is initialized.

Alarm 1 output characteristic setting screen

**R1\_R** no

Initial value: no  
Setting range: no, nc

MENU key

Alarm 1 output characteristics can be chosen from *no* : normal open and *nc* : normal close.  
This screen is not displayed when Alarm 1 mode is *non*.  
NOTE: When *nc* is chosen, relay turns ON after 500ms from power-on and turns OFF in alarm region.

Alarm 1 tone of buzzer setting screen

**R1\_b** 1

Initial value: 1  
Setting range: OFF, 1 ~ 3 2

MENU key

Can be set alarm 1 tone of buzzer from 1 to 32.  
Buzzer is not sounded when this screen set *OFF*.  
When the option is not added, these screens are not displayed.  
This screen is not displayed when Alarm 1 mode is *non*.

Alarm 1 sound time of buzzer setting screen

**R1\_t** cont

Initial value: cont  
Setting range: 1 ~ 1 0 0 sec., cont

MENU key

Can be set alarm 1 sound time of buzzer.  
Continue sound of buzzer between alarm 1 on action when set *cont*.  
When the option is not added, these screens are not displayed.  
This screen is not displayed when Alarm 1 tone of buzzer set is *OFF*.  
This screen is not displayed when Alarm 1 mode is *non*.

Alarm 2 mode setting screen

**R2\_n** LR

Initial value: LR  
Setting range: according to Alarm type code table

MENU key

Alarm type to be assigned to Alarm 2 can be chosen and set according to the code table.  
When measuring range, unit, or scaling range is changed the setting is initialized.

Alarm 2 differential gap setting screen

**R2\_d** 5

Initial value: 5 unit  
Setting range: 1 ~ 9 9 9 unit

MENU key

The same as those of Alarm 1

Alarm 2 stand-by action setting screen

**R2\_S** OFF

Initial value: OFF  
Setting range: OFF, 1, 2

MENU key

The same as those of Alarm 1

For Alarm 2 latching setting screen

Alarm 2 latching setting screen

**R2\_L** OFF

Initial value: OFF  
Setting range: OFF, ON

MENU key

The same as those of Alarm 1

Alarm 2 output characteristic setting screen

**R2\_R** no

Initial value: no  
Setting range: no, nc

MENU key

The same as those of Alarm 1

Alarm 2 tone of buzzer setting screen

**R2\_b** 2

Initial value: 2  
Setting range: OFF, 1 ~ 3 2

MENU key

The same as those of Alarm 1

Alarm 2 sound time of buzzer setting screen

**R2\_t** cont

Initial value: cont  
Setting range: 1 ~ 1 0 0 sec., cont

MENU key

The same as those of Alarm 1

Back to the lead screen of Mode 4

( 6 ) A group of Mode 5 screens

A group of Mode 5 screens are external control input(DI) option setting screens.

When the option is not added, these screens are not displayed.

DI input is either no-volt contact or open collector.

Lead screen of Mode 5

**mode** 5

There is no setting on this screen.  
Press ENT key and the screen will shift to the first setting screen, DI1 mode setting screen.

DI1 mode setting screen

**d1\_n** non

Initial value: non  
Setting range: according to DI action code table

MENU key

DI action to be assigned to DI 1 can be chosen and set according to the code table.

DI 2 mode setting screen

**d2\_n** non

Initial value: non  
Setting range: according to DI action code table

MENU key

DI action to be assigned to DI 2 can be chosen and set according to the code table.

Back to the lead screen of Mode 5

DI Action Code Table and Constraint Items

DI Action Code Table

DI Code	Action type	Input Detection	
non	No assignment		
SB2	Second SV	Level	Executed SV = Second SV with DI terminals closed
SB3	Third SV	Level	Executed SV = Third SV with DI terminals closed
run	Control run	Level	RUN with DI terminals closed STBY with DI terminals open
MAN	Manual Output	Level	Manual with DI terminals closed Automatic with DI terminals open
L-rs	Latching cancel	Edge	Latching cancellation with leading edge
AT	Auto tuning	Edge	AT operation with leading edge
LOCK	Super Key Lock	Level	Super Key Lock with DI terminals closed Cancellation with DI terminals open

- *SB2* and *SB3* actions are set to be executed during AT operation, the settings are executed when AT operation stops
- When *SB2* and *SB3* are assigned to each DI and when both of them are set to be executed simultaneously, *SB2* is the executed SV.
- *AT* can be executed at the time of RUN-automatic output operation.
- To cancel AT in half way while *AT* is assigned, choose OFF on AT screen.
- AT is cancelled when "STBY" or "manual output" is executed.
- DI action is still effective even when "key lock" is set at other than OFF.
- The same action cannot be assigned to DI 1 and DI 2
- The action assigned to DI takes precedence, and no key operation is possible.
- When "super key lock" is executed, the setting is fixed on the basic screen. While DI action can be executed, cancellation of AT or change of SV or manual output value cannot be changed.
- At the time of DI input, 12VDC 2mA is added.  
Switches and transistor should be tolerable to the condition.
- The distance of DI wiring should be within 30 meters

( 7 ) A group of Mode 6 screens

A group of Mode 6 screens are analog output option setting screens.  
When the option is not added, these screens are not displayed.

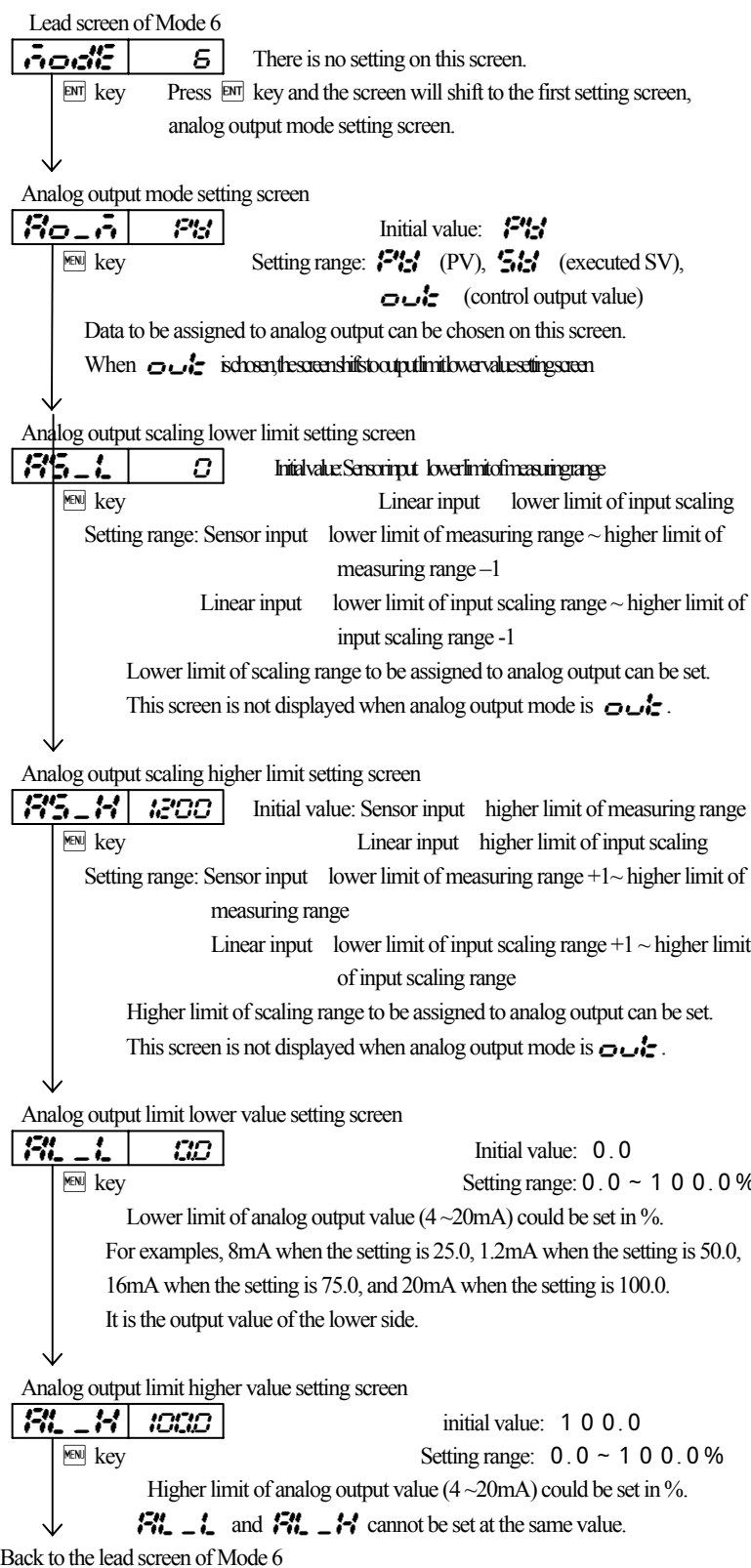

NOTE: Analog output limit can be set in reverse scaling.  
 Examples: Output range: 0 (4mA) ~ 1200°C (20mA) can be changed to 0 (20mA) ~ 1200°C (4mA) Set 100.0% in **RL\_L**, and set 0.0% in **RL\_H**

( 8 ) A group of Mode 7 screens

A group of Mode 7 screens are communication of RS-485 option setting screens.  
When the option is not added, these screens are not displayed.  
For details, please refer to the instruction manual for communication interface.

5 - 5 . Measuring range code table

Input type	Code	Measuring range	
		Unit code <b>C</b> ( )	Unit code <b>F</b> (°F)
Thermo Couple	R	0 ~ 1700	0 ~ 3100
	K	-199.9 ~ 400.0	-300 ~ 700
	K	0 ~ 1200	0 ~ 2200
	J	0 ~ 600	0 ~ 1100
	T	-199.9 ~ 200.0	-300 ~ 400
	E	0 ~ 700	0 ~ 1300
	S	0 ~ 1700	0 ~ 3100
	U	-199.9 ~ 200.0	-300 ~ 400
	N	0 ~ 1300	0 ~ 2300
	B	0 ~ 1800	0 ~ 3300
R.T.D.	<b>P1</b>	-200 ~ 600	-300 ~ 1100
Pt100	<b>P2</b>	-100.0 ~ 200.0	-150.0 ~ 400.0
	<b>P3</b>	0.0 ~ 100.0	0.0 ~ 200.0
0 ~ 10 mV	<b>A1</b>	Scaling range : -1999 ~ 9999 count	
0 ~ 100 mV	<b>A2</b>	Span : 10 ~ 10000 count	
1 ~ 5 V	<b>B1</b>	decimal point changeable	
0 ~ 5 V	<b>B2</b>		
4 ~ 20 mA	<b>C1</b>	At the time of current input	
0 ~ 20 mA	<b>C2</b>	Attached external resistance 250 at the <b>C</b> code	

5 - 6 . Drawing of alarm action

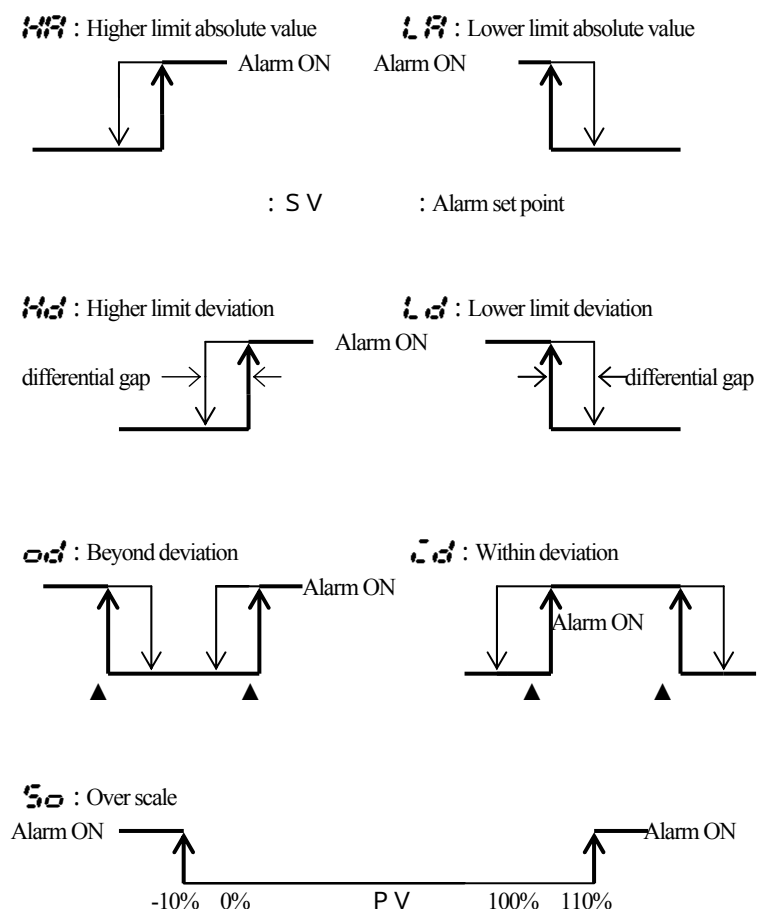

## 6 . Principal Specification

### General specifications

Supply voltage : 90 – 264V AC 50/60Hz or 21.6 – 26.4V AC(50/60Hz)/ DC  
 Power consumption : 90 – 264V AC 7VA maximum, 24V AC 4VA maximum, 24V DC 3W maximum  
 Applicable standard Safety : IEC1010-1and EN61010-1:2001  
 EMC : EN61326-1:1997+Amendment1:1998+Amendment2:2001 (EMI: Class A, EMS: Annex A)  
 EN61000-3-2:2000 EN61000-3-3:1995+Amendment1:2001

### Use environment

Temperature : 0 ~ 50 °C  
 Humidity : below 90%RH (no condensation)  
 Altitude : 2000 m above sea level max. Category : Pollution degree : 2

Storage temperature : -20 ~ 65  
 Protective structure : Only front panel has dust-proof and drip-proof structure. Equivalent to IP66 Applicable standard IEC60529: 1989+Amendment: 1999  
 IP66 Required thickness of applicable panel: 1.2, 1.6, 2.0, 2.3, 2.8, 3.2mm (1 ~ 4mm with metal fittings)  
 Insulation resistance : Between input/output terminal and power supply terminal 500V DC 20M min. /1500V AC per minute  
 / withstand voltage : Between analog output or external control input and other input/output terminals 500V DC 20M min. /500V AC per minute  
 Quake resistance : Frequency 10 ~ 55 ~ 10Hz Amplitude 0.75mm (half) ...100m/s Direction 3 directions  
 Sweep rate 1 octave/ minute (reciprocation approx. 5 minutes/ cycle) Number of sweep 10 times Applicable standard IEC60068-2-6/1995  
 Case material : P P O  
 External detention : H24 × W48 × D107mm (The depth detention of panel inside 100mm)  
 Weight : Approx. 60g (without panel metal fittings)

### Display

Display accuracy : ± (0.3%FS+1 digit) CJ measurement errors excluded No guarantee at 400 °C or below in B thermocouple  
 During EMC test the accuracy is 5%FS  
 Display accuracy range : 23 ± 5  
 Measured value display range : -10% ~ 110% of measuring range (-240 ~ 680 °C in case of the measuring range of R.T.D. -200~600 °C)

### Input

Thermocouple Input impedance : 500k min. External resistance range 100 min. max.  
 Cold junction temperature : 1 (ambient temperature of 18 ~ 28 °C) 2 (ambient temperature of 0 ~ 50 °C)  
 compensation accuracy ± 0.5%FS (the index value is -100 ~ 0 °C) ± 1.0%FS (the index value is below -100 °C)  
 R.T.D. Standard current : 0.25 mA  
 Voltage Input impedance : 500k min.  
 Current Receiving impedance: 250 Ω (The accessories external resistance should be connected to the input terminal.)

### Control

Control type / rating : Contact 1a/ 240V AC 2A (resistive load)  
 : Voltage pulse (SSR drive voltage) / 12V DC +1.0V ~ -1.5V 20mA max.  
 : Current / 4 ~ 20mA DC Load resistance 500 Ω max.

### Alarm output

Alarm type/ rating : Contact 1a/ 240V AC 2A (resistive load)

### External control input (DI)

Input type/rating : No-volt contact or open collector / approx. 12V DC 2mA the distanced of DI wiring should be within 30 meters.

### Analog output

Output rating : 4 ~ 20mA DC Load resistance 300 Ω max.

### Insulation

: Control output is not insulated except input, system, key input/display and contact.  
 Not insulated between alarm output AL1 and AL2.  
 The rest are basic insulation or functional insulation. Refer to the insulation block chart shown below.

### Insulation block chart

————— basic insulation      ————— Functional insulation      ..... No insulation

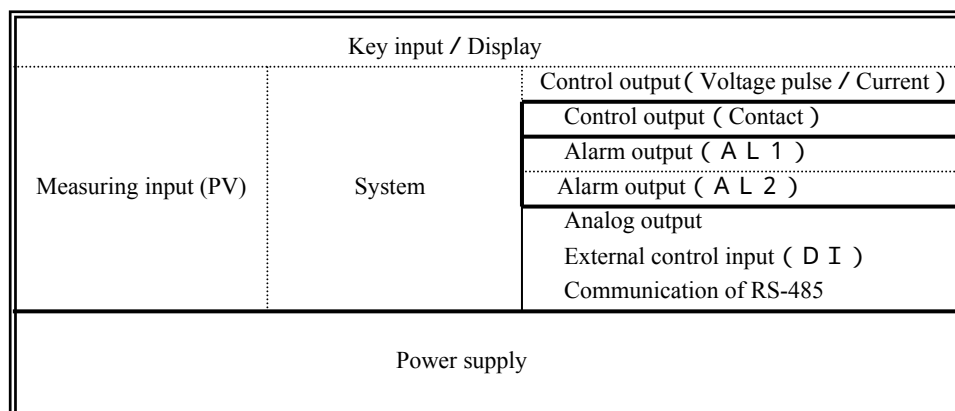

The contents of this instruction are subject to change without notice.

**S H I M A X CO., LTD.**

URL; <http://www.shimax.co.jp>

Head Office: 8-50 Tohrimachi, Ohmagari-shi, Akita 014-0027 Japan

Phone: 0187-86-3400 Facsimile:0187-62-6402

PRINTED IN JAPAN T0404