

# Three Phase Solid State Relay

the DS&TS Series solid-state power controllers are available in TS Series three-phase, three - leg ;or DS Series three phase, two-leg versions.

They provide high-reliability control of resistive heating loads to 120 amps

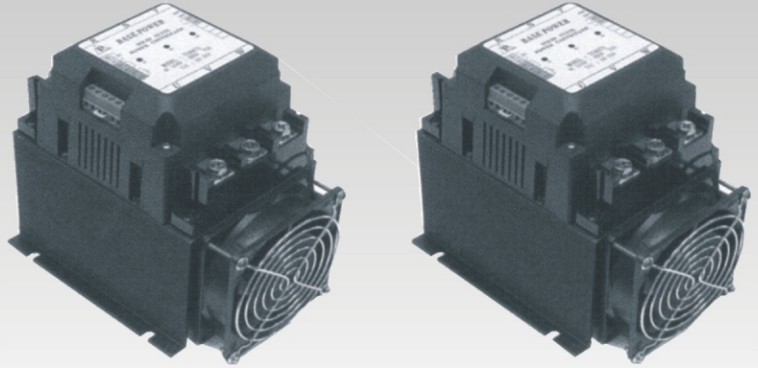

20-120A

- Current ratings from 20 to 120 A
- Output voltage rating to 480 Vac
- Zero-cross firing eliminates RFI/EMI
- AC or DC control inputs
- Optical isolation • Maintenance-free
- Replaces mercury and mechanical contactors
- Extends heater life by reducing thermal shock
- Input LED indication
- -10 to 50 °C operating temperature

## Ordering Information

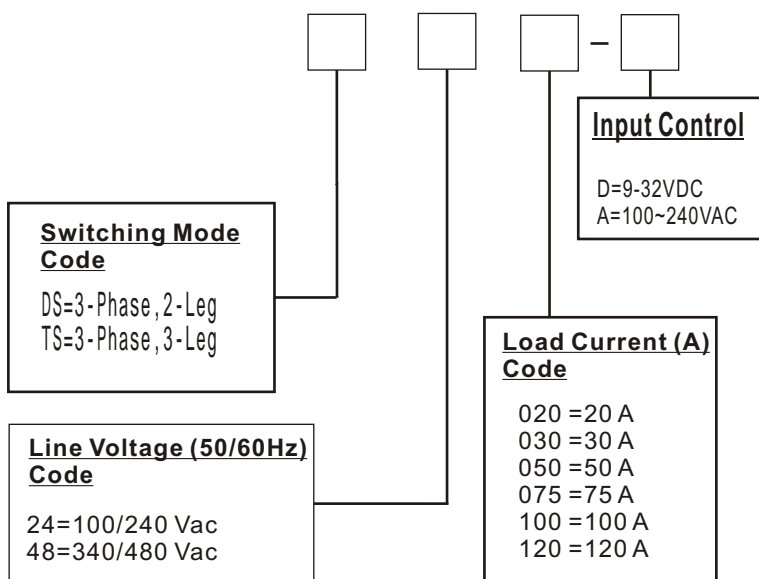

## Specifications

### INPUT SPECIFICATIONS

Control Voltage:9-32 Vdc and 100-240 Vac  
Drop-Out Voltage:7.0 Vdc  
Maximum Input Current:12 mA

### OUTPUT SPECIFICATIONS

Continuous On-State  
Current: 3-phase,3-leg 20 -120A  
3-phase,2-leg 20 -120 A







Minimum  
On-State Current: 0.6A  
On-State Voltage Drop: 100V peak

### GENERAL SPECIFICATIONS

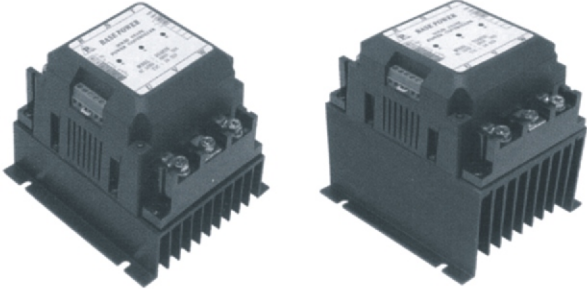
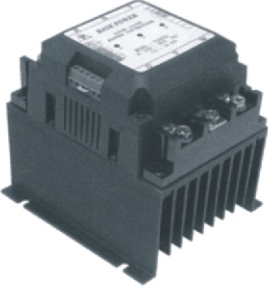
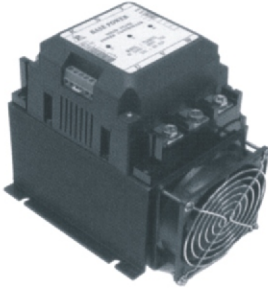
Storage Temperature: -10 to 50°C  
Input/Output Isolation Voltage: 1200 Vrms  
Input/Outputto  
Ground Isolation Voltage: 1200 Vrms  
Line Voltage: 100 to 250 Vac or 100 to 480 Vac  
Line Frequency: 50 to 60 Hz

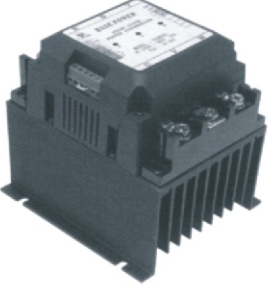
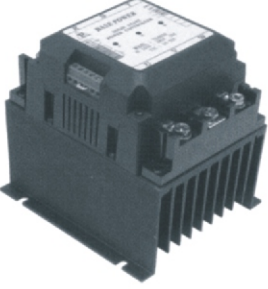
# SERIES DS&TS SOLID-STATE POWER CONTROLS

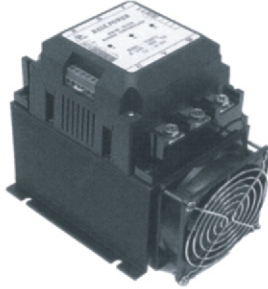
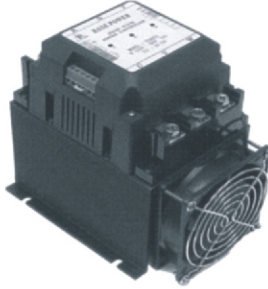
(LXWXH)mm

<p>DS2420 DS4820</p>  <p>143X128X116mm(1000g)</p>	<p><b>20A</b></p>  <p>143X128X170mm(1500g)</p>	<p>TS2420 TS4820</p>	<p>DS2475 DS4875</p>  <p>173X128X170mm(2000g)</p>	<p><b>75A</b></p>  <p>173X128X170mm(2200g)</p>	<p>TS2475 TS4875</p>
<p>DS2430 DS4830</p>  <p>143X128X170mm(1500g)</p>	<p><b>30A</b></p>  <p>143X128X170mm(1600g)</p>	<p>TS2430 TS4830</p>	<p>DS24100 DS48100</p>  <p>173X128X170mm(2000g)</p>	<p><b>100A</b></p>  <p>236X128X170mm(2500g)</p>	<p>TS24100 TS48100</p>
<p>DS2450 DS4850</p>  <p>173X128X170mm(2000g)</p>	<p><b>50A</b></p>  <p>173X128X170mm(2200g)</p>	<p>TS2450 TS4850</p>	<p>DS24120 DS48120</p>  <p>173X128X170mm(2000g)</p>	<p><b>120A</b></p>  <p>236X128X170mm(2500g)</p>	<p>TS24120 TS48120</p>

## Terminal Connection:

